

Charpy impact toughness and transition temperature in ferrite – perlite steel

Tenacidad al impacto y temperatura de transición en aceros ferrítico-perlíticos

C. S. Cubides-Herrera  ; D. A. Villalba-Rondón  ; R. Rodríguez-Baracaldo 

Abstract— The Charpy impact test is a significant tool for the determination of fundamental properties for materials selection in mechanical designs, like the impact toughness and the brittle-ductile transition temperature. Charpy V-notch impact tests on 10 mm thick, Dual-Phase ferrite-perlite steel were evaluated at temperatures ranging from 90 °C to -60 °C. Fracture surfaces were analysed by optical microscope (OM). Due to the high dispersion, showed in the results, numerous tests under the same conditions and the use of statistical methods are needed to obtain a reliable value. The transition temperature calculated (45 °C) and Charpy impact toughness was analysed in function of microstructure and carbon equivalent.

Index Terms—Charpy, ferrite, impact toughness, perlite.

Resumen—Las pruebas de impacto son una importante herramienta para la obtención de importantes propiedades, como la tenacidad al impacto y la temperatura de transición dúctil-frágil, para la selección de un material en diseño mecánico. Se evaluó la tenacidad al impacto mediante pruebas de impacto Charpy en acero de fase doble (ferrita-perlita) de 10 mm de espesor a temperaturas que oscilan entre 90 °C y -60 °C. Las superficies de fractura fueron analizadas por microscopio óptico (MO). Debido a la alta dispersión, mostrada en los resultados, se emplaron numerosas pruebas en las mismas condiciones y el uso de métodos estadísticos para obtener un valor confiable. La temperatura de transición calculada (45 °C) y la resistencia al impacto de Charpy se analizaron en función de la microestructura y el equivalente de carbono

Palabras claves— Charpy, ferrita, tenacidad, impacto, perlita.

I. INTRODUCTION

The dual-phase steels are usually the most efficient solution for engineering issues, which requires specific performance conditions. Those steels are obtained through relatively simple methods by varying its composition or applying some heat treatments [1]. The dual phase ferrite- perlite steel is one of the most common materials in terms of carbon steels because of its great versatility. This material allows many additional processes as diverse heat treatments, like annealing,

carburization, nitriding, normalization and good weldability. Due to this fact, this material has a huge application range, among which the manufacturing of some mechanical parts especially highlights.

The Charpy impact test is such a significant tool for the determination of fundamental data for design aspects, like the impact toughness, the brittle-ductile transition temperature, that is, by definition, the temperature in which the material changes its behaviour from ductile to a brittle one; besides others. Those properties define behaviours that considerably affect the material performance in different application environments. The obtained data are crucial to establish safe design parameters.

Nowadays, it is commonly worked between a wide condition range (from under zero temperatures [2] to temperatures close to the 600°C [3]). The design parameters for extreme conditions, such as the mentioned, have the Charpy impact test in common. This test is a simple (with few restrictions) and powerful, and for that reason has many applications. Nevertheless, it is remarkable the fact that, it has many variables to be properly controlled to achieve a useful result.

The examination of the fracture surfaces is a very important process, because it lets get a complementary evaluation of the ductile- brittle transition temperature. Categorizing the shear-fracture (fibrous fracture) and cleavage-fracture (granular fracture) offer relevant information of the toughness. The classification method is usually based on the shear-fracture percentage, in which a 100% indicates a ductile fracture (above the transition temperature) although there are generally mixed fracture [4].

Experimental, theoretical and numerical studies of the relationship between the transition temperature and the microstructural features in ferrite-perlite steels have been reported in the literature. Nevertheless, the fracture mechanisms on impact test specimens have not been fully understood. The aim of this study is to determine the relationship among the transition temperature, energy absorbing capacity, chemical composition and microstructural characteristic of ferrite-perlite steels.

This manuscript was sent on December 11, 2018 and accepted on June 06, 2019. The authors acknowledge the financial support received from Universidad Nacional de Colombia, Bogotá.

C.S. Cubides-Herrera. Mechanical Engineering, Universidad Nacional de Colombia, Car 30 No 45-03, Ed-407, Of-103. Bogotá D.C, Colombia (email: escubidesh@unal.edu.co).

D.A. Villalba-Rondon. Mechanical Engineering, Universidad Nacional de Colombia, Car 30 No 45-03, Ed-407, Of-103. Bogotá D.C, Colombia (email: davillalbar@unal.edu.co).

R. Rodríguez Baracaldo. Ing. Ms. Dr. Profesor del Departamento de Ingeniería Mecánica y Mecatrónica, Universidad Nacional de Colombia, Car 30 No 45-03, Ed-407, Of-103. Bogotá D.C, Colombia (email: rodriguezba@unal.edu.co).

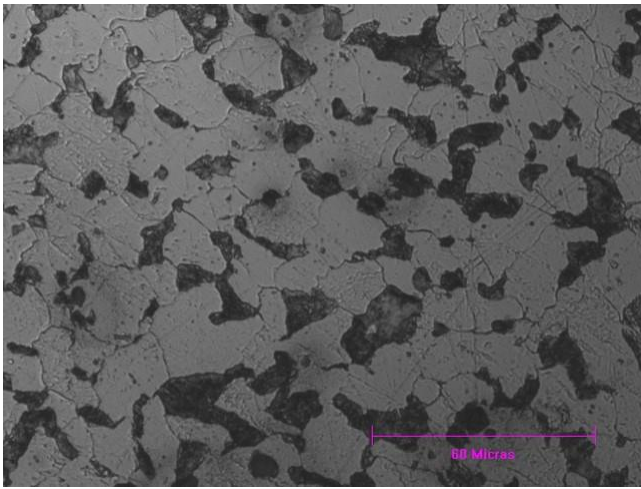

Fig 1. Optical micrograph of a Ferrite – perlite steel

II. MATERIALS AND METHODS

As received material was provided in a hot rolled condition. Chemical composition determined by optical emission spectrometry is showed in table I. Samples were heating above the critical temperature (910 °C) , holding for 300s for transformation to and air cooling. This Normalized heat treatment establishes a more uniform carbide size and distribution. Figure 1 shows optical micrograph of ferrite - perlite steel. The shape of ferrite grain is regular and perlite distribution appears in grain boundaries homogeneously distributed because of normalized heat treatment.

TABLE I.
CHEMICAL COMPOSITION OF USED FERRITIC-PERLITIC STEEL

Element	C	Si	Mn	P	S	Cr	Ni	Mo	Fe
%WT	0.174	0.156	0.788	0.022	0.012	0.01	0.036	0.012	98.67

Samples are prepared according to ASTM E23-16b standard. The dimensions of the samples are 10mm x 10mm x 55mm with a 2 mm deep 45° V-notch, sample schema is presented in the fig. 2. The samples were tested with variable temperature from -60°C to 92°C, in order to determine the transition temperature. The samples temperature was varied through a liquid medium. Alcohol with liquid nitrogen was used to cool and hot water was used to warm the samples. Stabilization times of 5 minutes for samples and tongs was taken into account. Finally, (fig. 3 shows the fracture surface percentage was obtained according to ASTM E23-16b [4].

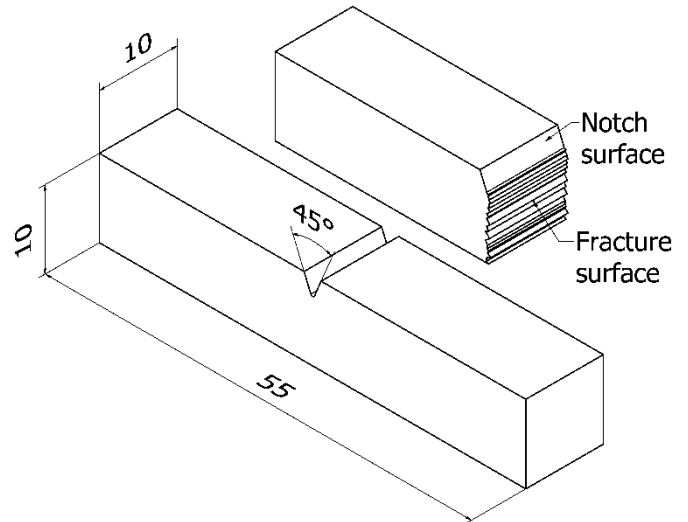

Fig 2. Sample schema

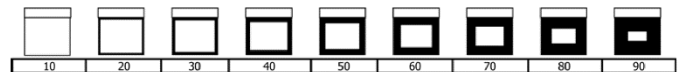

Fig 3. Estimated percentage. Adapted from [4]

III. RESULTS AND DISCUSSION

The resulted fracture surfaces of the tests with the lowest temperatures are shown in figure 4. In this test set, implemented with under zero temperatures, it is evident that the percentage of cleavage fracture is 100%, so it is a totally fragile or brittle fracture under the transition temperature of the material. That is why, it is hard to recognize a big difference between the related surfaces.

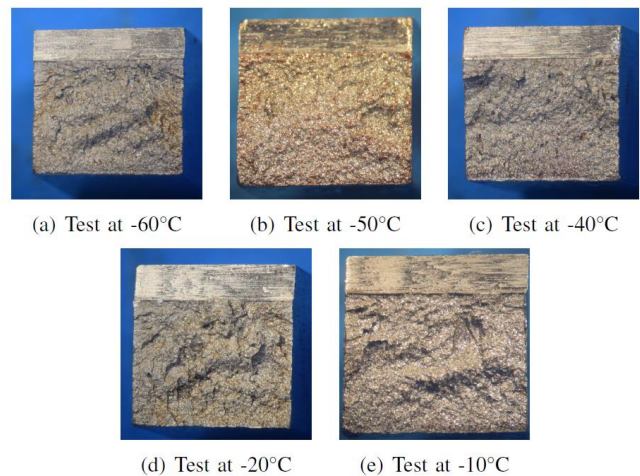

Fig 4. Fracture surface at under zero temperatures.

Fracture surfaces obtained by higher temperature tests are showed in Fig. 5. In this case Figure 5(a), 5(b), a increase of shear-fracture percentage was obtained (approximately 5% to 10%). Nevertheless, in the figure 5(c), 5(d) and 5(e) a significant rise in the shear-fracture percentage can be

appreciated (between 30% and nearly 40%), it means that the test started to approach a little the transition temperature, where also the shear lips could be appreciated.

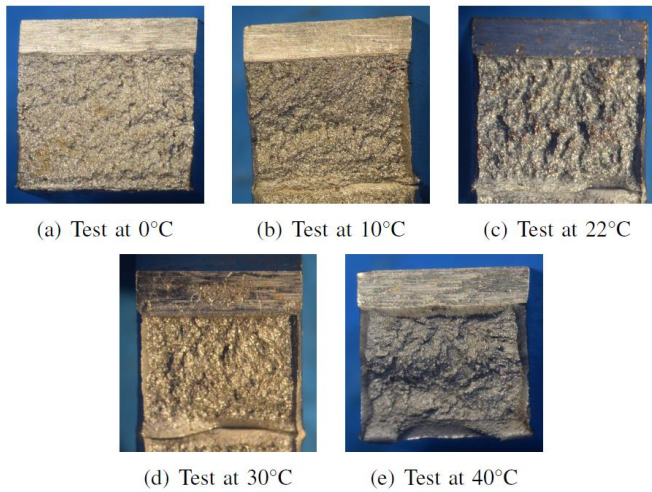

Fig 5. Fracture surfaces at mean temperature tests

Viewing the results of the highest temperatures tests (Fig. 6), it is observed a high shear-fracture percentage. In a more specific approach, it could be stated that those fracture surfaces were made due to tests over the transition temperature, since the percentage of those surfaces are almost 60% or 70%. That means that the transition temperature might be in a range between 40°C and 50°C.

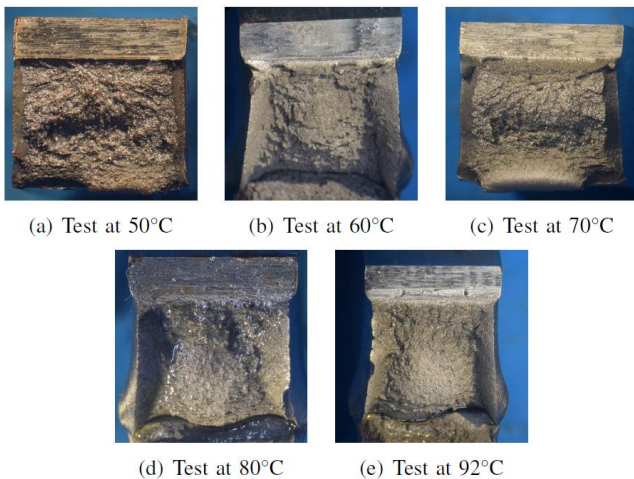

Fig 6. Fracture surfaces higher temperature tests

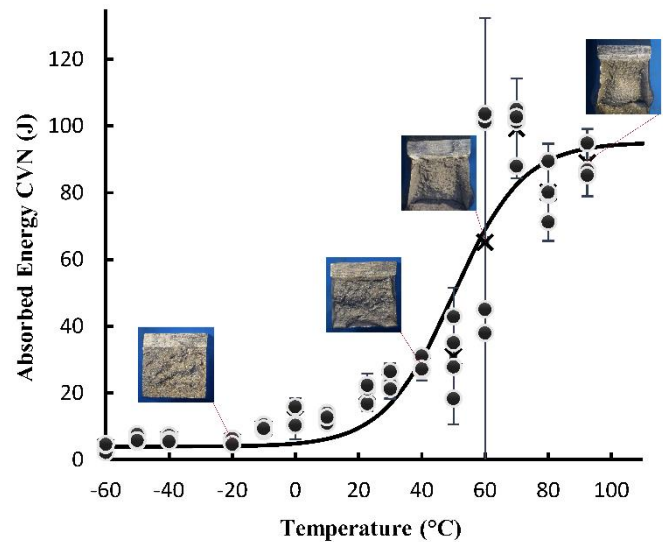

Fig 7. Temperature vs. Absorbed energy

With the absorbed energy vs temperature graphic, the transition temperature curve of the worked ferritic-perlitic steel was obtained and the following facts were deduced:

- 1) The temperature in which the material is completely ductile is 80°C.
- 2) The temperature in which the material is completely brittle is approximately 10°C.
- 3) The average of the temperatures 1 and 2, equivalent to the material's transition temperature (the middle point between being ductile or brittle) is 45°C.

It could be appreciated that the absorbed energy between the -60°C and 0°C is so similar and shows a very slow rise. However, between 10°C and 80°C it has a different behaviour, since the absorbed energy increases dramatically until stabilises at 90°C.

As seen in the fit-function's equation (1) [5]. The parameters a_i can be determined, being: $a_1 = 0.4$, $a_2 = 9.7$, $a_3 = 50$. y is expressed in [Kg · m].

$$y = \frac{a_1}{2} \left[1 - \tanh\left(\frac{T - a_3}{a_4}\right) \right] + \frac{a_2}{2} \left[1 + \tanh\left(\frac{T - a_3}{a_4}\right) \right] \quad (1)$$

Where the parameters might be read as: a_1 the minimum value of Y ; a_3 is the temperature in which the parabolic tangential function has an inflection point; and a_4 is the measure of the range where the transitional behaviour occurs.

Furthermore, it is observed that the trustworthiness range based on the measured data for the 60°C temperature is considerable, that means, there is a huge variance in this temperatures (common within the ductile temperature range) [6] and it needs enough data (around 5 tries each 5°C) to determine exactly the curve profile with its own statistical treatment [7].

In comparison, with some previous studies [8] - [9], it is found out that in quenching and temperable steels, such as the 4340, the main values of absorbed energy are 57J for the dual phase tempered bainite-ferrite, which is the one with the highest

toughness. Followed by 36J of bainite-ferrite, 20J for the whole bainite microstructure, 11J for the martensite-ferrite and the least is the martensite (6J), all data were taken at room temperature. Although the steel tested for this particular study has ferrite-perlite structure (a hardly-temperable steel), the absorbed energy tends to be higher at room temperature. Nevertheless, it is not proper to compare the absorbed energy parameter between different tests, because the conditions vary and is impossible to ensure all the conditions and the machine systematic errors. The quantification of this energy is only useful to determine the curve behaviour. Also, it is important to take into account the cleavage-characteristic stress, in order to determine more efficiently the transition temperature and the velocity by which the test is carried out [10].

Another considerable factor to explain the behaviour differences between dual phase steels is the equivalent carbon, that influences directly the toughness of the material. The resulted carbon equivalent for the worked steel shows a percentage of 0.2116% (using (2) according to [11]), which is comparatively low, taking into consideration that, for the 4340 (high-alloyed steel), it nearly doubles this value.

$$CE = C + 0.3(Si) + 0.33(P) - 0.027(Mn) + 0.4(S) \quad (2)$$

Finally, it can be stated that it is extremely complicated to make such a reliable test, since there are always multiple factors that make increase the error dramatically. The test was not executed following strictly to ASTM E23-16b standard, due mainly to availability of samples, making hard a suitable statistical treatment for considering a Weibull distribution [7]. Most of his scatter is due to difficulties in preparing reproducible notches, while some is due to variability of the exposure times in the medium with temperature and variability the velocity at which the operator set the specimen in the impact place. However, it was achieved a satisfactory behavior approach of the absorption energy during the impact as a temperature function of a dual phase ferrite- perlite steel.

IV. CONCLUSIONS

The impact test results do not only depend on the material or temperature, but also on endless variables, which contribute to rise the data dispersion.

If a test is realised close to the transition temperature, tiny temperature changes generate huge changes in the absorption energy of the material.

Due to the high data dispersion it is required the use of complex mathematical methods to obtain a good behaviour approach.

The fracture surface analysis may be a very useful tool to deduce the range, in which the transition temperature is to be found.

The impact tests give data with very high dispersion, so that numerous tests under the same conditions (tries) are needed in order to obtain a reliable value.

ACKNOWLEDGMENT

The authors acknowledge the financial support received from Universidad Nacional de Colombia, Bogotá.

V. PUBLICATION PRINCIPLES

The two types of contents of that are published are; 1) peer-reviewed and 2) archival. The Transactions and Journals Department publishes scholarly articles of archival value as well as tutorial expositions and critical reviews of classical subjects and topics of current interest.

Authors should consider the following points:

- 1) Technical papers submitted for publication must advance the state of knowledge and must cite relevant prior work.
- 2) The length of a submitted paper should be commensurate with the importance, or appropriate to the complexity, of the work. For example, an obvious extension of previously published work might not be appropriate for publication or might be adequately treated in just a few pages.
- 3) Authors must convince both peer reviewers and the editors of the scientific and technical merit of a paper; the standards of proof are higher when extraordinary or unexpected results are reported.
- 4) Because replication is required for scientific progress, papers submitted for publication must provide sufficient information to allow readers to perform similar experiments or calculations and use the reported results. Although not everything need be disclosed, a paper must contain new, useable, and fully described information. For example, a specimen's chemical composition need not be reported if the main purpose of a paper is to introduce a new measurement technique. Authors should expect to be challenged by reviewers if the results are not supported by adequate data and critical details.
- 5) Papers that describe ongoing work or announce the latest technical achievement, which are suitable for presentation at a professional conference, may not be appropriate for publication.

REFERENCES

- [1] H. K. Sung, S. Y. Shin, B. Hwang, C. G. Lee, N. J. Kim, and S. Lee, "Effects of carbon equivalent and cooling rate on tensile and charpy impact properties of high-strength bainitic steels," *Materials Science and Engineering: A*, vol. 530, pp. 530 – 538, 2011. DOI: 10.1016/j.msea.2011.10.015
- [2] S. Y. Shin, B. Hwang, S. Lee, N. J. Kim, and S. S. Ahn, "Correlation of microstructure and charpy impact properties in api x70 and x80 line- pipe steels," *Materials Science and Engineering: A*, vol. 458, no. 1, pp. 281 – 289, 2007. DOI: 10.1016/j.msea.2006.12.097
- [3] S. V. Panin, P. Maruschak, I. Vlasov, and B. Ovechkin, "Impact toughness of 12cr1mov steel. part1 – influence of temperature on energy and deformation parameters of fracture," *Theoretical and Applied Fracture Mechanics*, vol. 83, pp. 105 – 113, 2016. ICEAF-IV Engineering Against Failure. DOI: 10.1016/j.tafmec.2015.12.008
- [4] Standard Test Methods for Notched Bar Impact Testing of Metallic Materials, ASTM E23-16b, ASTM International, West Conshohocken, PA, USA, 2016, DOI: 10.1520/e0023-16b

- [5] MP Machinery and L. Testing, Charpy data fitting [online]. Available: <http://www.mpmachineryandtesting.com/charpy-data-fitting/>
- [6] Standard Test Method for Determination of Reference Temperature, T_0 , for Ferritic Steels in the Transition Range, ASTM E1921-18, ASTM International, West Conshohocken, PA, USA, 2018, DOI: 10.1520/e1921-18
- [7] R. Smith, A. Horn, and A. Sherry, "Relating charpy energy to fracture toughness in the lower transition region using a weibull stress dependent energy scaling model," *International Journal of Pressure Vessels and Piping*, vol. 166, pp. 72 – 83, 2018. DOI: 10.1016/j.ijpvp.2018.06.001
- [8] N. Saeidi and A. Ekrami, "Comparison of mechanical properties of martensite/ferrite and bainite/ferrite dual phase 4340 steels," *Materials Science and Engineering: A*, vol. 523, no. 1, pp. 125 – 129, 2009. DOI: 10.1016/j.msea.2009.06.057
- [9] N. Saeidi and A. Ekrami, "Impact properties of tempered bainite–ferrite dual phase steels," *Materials Science and Engineering: A*, vol. 527, no. 21, pp. 5575 – 5581, 2010. DOI: 10.1016/j.msea.2010.05.015
- [10] W. Lei, X. Yan, and M. Yao, "Ductile/brittle transition condition in charpy v-notch impact test in structural steel," *Engineering Fracture Mechanics*, vol. 46, no. 4, pp. 601 – 605, 1993. DOI: 10.1016/0013-7944(93)90166-P
- [11] ASM Hand- book, Volume 1: Properties and Selection: Irons, Steels, and High- Performance Alloys, 10th ed., ASM International. 1990, pp. 15 – 38.
- [12] S. Polanco Espezua, V. Alves Guimaraes, and R. B. Penteado, "Determinación de la temperatura de referencia to de la curva maestra en aceros de alta resistencia y baja aleación," Presented at: CIBIM8 2007 [Online]. Available: <http://congreso.pucp.edu.pe/cibim8/pdf/15/15-40.pdf>



Rodolfo Rodríguez-Baracaldo received the Bs. Eng in Mechanical Engineering in 1997 from the Universidad Nacional de Colombia, the MS degree in Materials and Processes in 1999, and the PhD degree in Materials Engineering and Metallurgy in 2008 from Universidad Politécnica de Cataluña, (España). He worked for the Universidad Nacional de Colombia since 2000. Currently, he is a Full Professor in the Mechanical and

Mechatronics Department, Facultad de Ingeniería, Universidad Nacional de Colombia. His research interests include: Mechanical Metallurgy, Mechanical Properties of Advanced Materials, Metal Forming And Computational Materials Modeling And Simulation.

ORCID: <http://orcid.org/0000-0003-3097-9312>



Cristian Sebastián Cubides-Herrera has been studying the B.S. degree in mechanical engineering from the National University of Colombia (Universidad Nacional de Colombia).

He took part in the South American Space Generation Workshop 2018, that took place on Bogotá on November 9th and 10th with the specialization of Space Entrepreneurship. His interests include

material sciences, aerothermodynamics and energy generation. Cubides has been working in the investigation group GIDA UN (in Spanish, it stands for Investigation Group for Aerospace Development) since 2018 and was recipient of the Academic Excellence Honour (matrícula de honor) of the career in the following periods: 2017-2 and 2018-1.

ORCID: <http://orcid.org/0000-0001-8290-190X>



Diego Alejandro Villalba-Rondón has been studying the B.S. degree in mechanical engineering from the Universidad Nacional de Colombia. He has been working in the investigation group GIDA UN and some studies on materials science since 2018. His interests include turbomachinery, material and thermal sciences. Mr. Villalba's awards

and honors include the Academic Excellence Honour of the career in the following periods: 2016-2 and 2017-1.

ORCID: <http://orcid.org/0000-0002-7077-6774>